

XN09D61

Silicon PNP epitaxial planar type (Tr)
Silicon epitaxial planar type (SBD)

For DC-DC converter

■ Features

- Two elements incorporated into one package (Tr + SBD)
- Reduction of the mounting area and assembly cost by one half
- Low collector-emitter saturation voltage $V_{CE(sat)}$

■ Basic Part Number

- 2SA2046 + MA3ZD12

■ Absolute Maximum Ratings $T_a = 25^\circ\text{C}$

	Parameter	Symbol	Rating	Unit
Tr	Collector-base voltage (Emitter open)	V_{CBO}	-15	V
	Collector-emitter voltage (Base open)	V_{CEO}	-15	V
	Emitter-base voltage (Collector open)	V_{EBO}	-5	V
	Collector current	I_C	-1.5	A
	Peak collector current	I_{CP}	-3	A
SBD	Reverse voltage	V_R	20	V
	Repetitive peak reverse voltage	V_{RRM}	25	V
	Forward current (Average)	$I_{F(AV)}$	700	mA
	Non-repetitive peak forward surge current	I_{FSM}	2	A
Overall	Total power dissipation *	P_T	600	mW
	Junction temperature	T_j	125	$^\circ\text{C}$
	Storage temperature	T_{stg}	-55 to +125	$^\circ\text{C}$

Note) *: Measuring on ceramic substrate at 15 mm × 15 mm × 0.6 mm

■ Electrical Characteristics $T_a = 25^\circ\text{C} \pm 3^\circ\text{C}$

- Tr

Parameter	Symbol	Conditions	Min	Typ	Max	Unit
Collector-base voltage (Emitter open)	V_{CBO}	$I_C = -10 \mu\text{A}, I_E = 0$	-15			V
Collector-emitter voltage (Base open)	V_{CEO}	$I_C = -1 \text{ mA}, I_B = 0$	-15			V
Emitter-base voltage (Collector open)	V_{EBO}	$I_E = -10 \mu\text{A}, I_C = 0$	-5			V
Collector-base cutoff current (Emitter open)	I_{CBO}	$V_{CB} = -10 \text{ V}, I_E = 0$			-0.1	μA
Forward current transfer ratio *	h_{FE}	$V_{CE} = -2 \text{ V}, I_C = -100 \text{ mA}$	160		560	—
Collector-emitter saturation voltage *	$V_{CE(sat)}$	$I_C = -750 \text{ mA}, I_B = -15 \text{ mA}$		-90	-200	mV
		$I_C = -1.5 \text{ A}, I_B = -50 \text{ mA}$		-130		

Note) 1. Measuring methods are based on JAPANESE INDUSTRIAL STANDARD JIS C 7030 measuring methods for transistors.

2. *: Pulse measurement

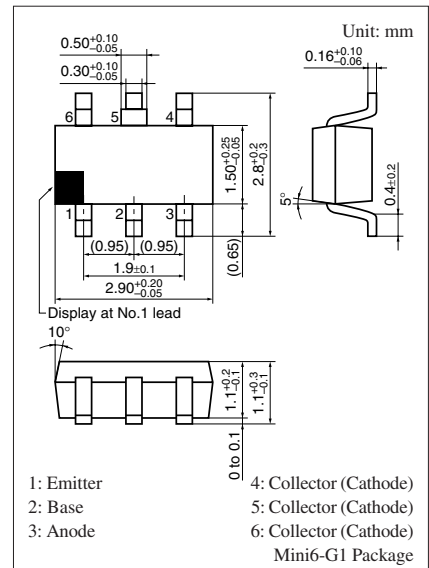

Marking Symbol: RA

Internal Connection

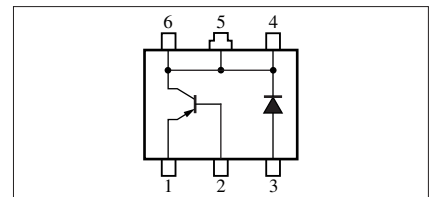

■ Electrical Characteristics (continued) $T_a = 25^\circ\text{C} \pm 3^\circ\text{C}$

• Tr (continued)

Parameter	Symbol	Conditions	Min	Typ	Max	Unit
Collector output capacitance (Common base, input open circuited)	C_{ob}	$V_{CB} = -10\text{ V}, I_E = 0, f = 1\text{ MHz}$		25	35	pF
Transition frequency	f_T	$V_{CB} = -2\text{ V}, I_E = 100\text{ mA}, f = 200\text{ MHz}$		270		MHz
Turn-on time	t_{on}	Refer to the switching time measurement circuit		25		ns
Storage time	t_{stg}			70		ns
Turn-off time	t_{off}			15		ns

Note) Measuring methods are based on JAPANESE INDUSTRIAL STANDARD JIS C 7030 measuring methods for transistors.

Switching time measurement circuit

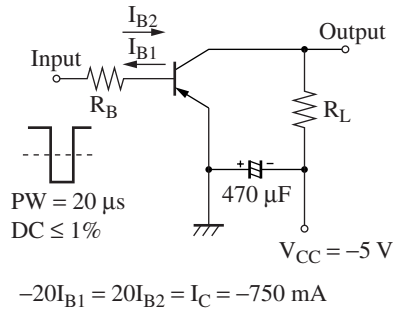

• SBD

Parameter	Symbol	Conditions	Min	Typ	Max	Unit
Forward voltage	V_F	$I_F = 700\text{ mA}$			0.45	V
Reverse current	I_R	$V_R = 20\text{ V}$			200	μA
Terminal capacitance	C_t	$V_R = 0, f = 1\text{ MHz}$		100		pF
Reverse recovery time	t_{rr}	$I_F = I_R = 100\text{ mA}, I_{tr} = 10\text{ mA}$ $R_L = 100\ \Omega$		7		ns

Note) 1. Measuring methods are based on JAPANESE INDUSTRIAL STANDARD JIS C 7031 Measuring methods for diodes.

2. Schottky barrier diode is frail with static electricity, and it should be kept in safety from shock of static electricity and static electricity level.

Common characteristics chart

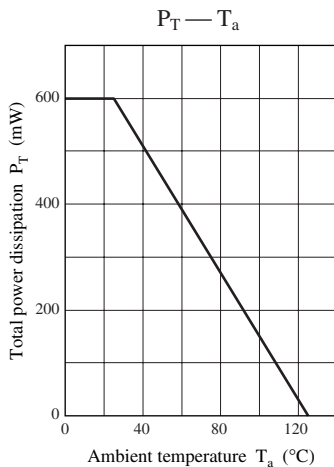

Characteristics charts of Tr

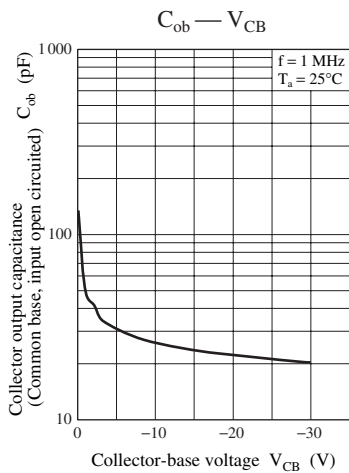
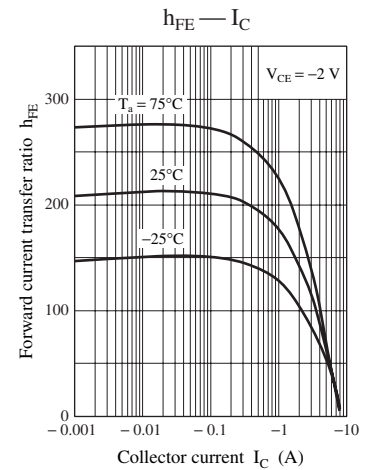
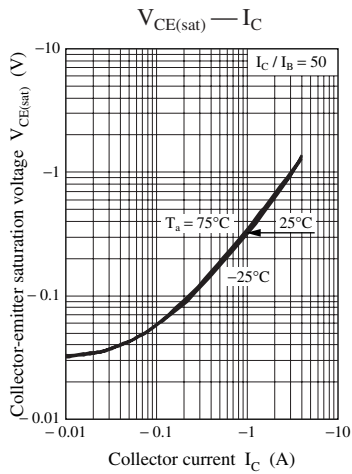
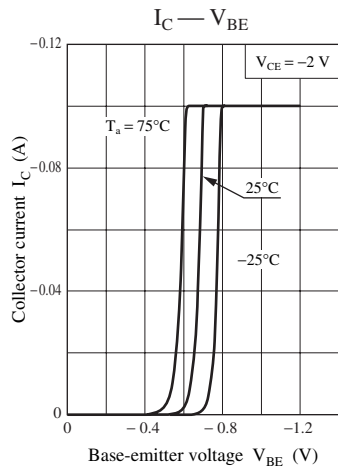
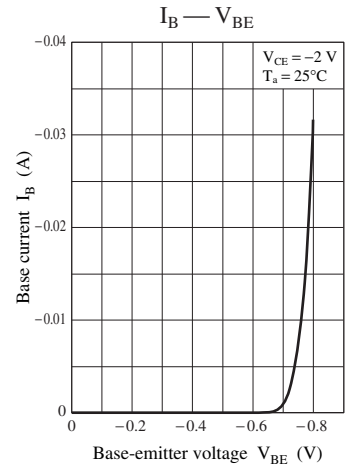
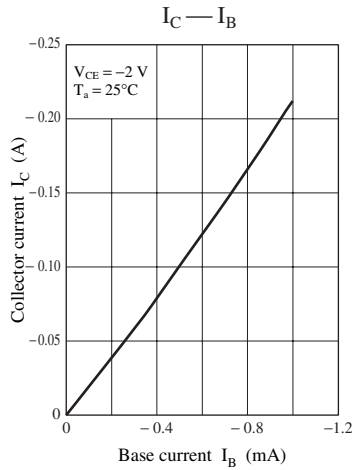
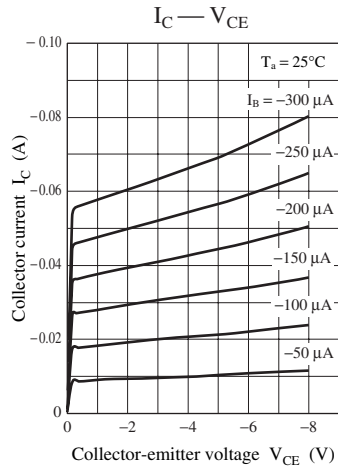

Characteristics charts of SBD

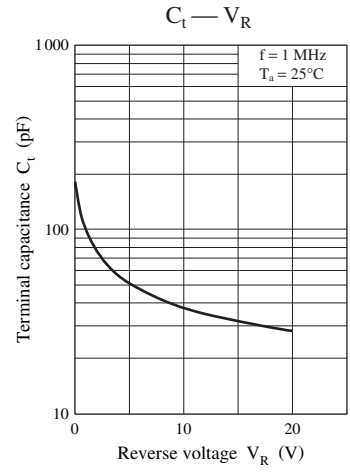
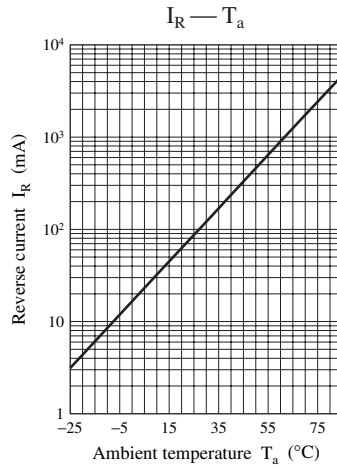
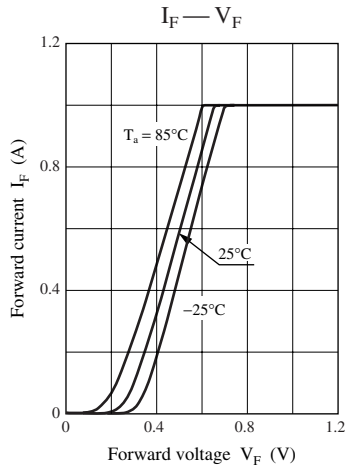

Request for your special attention and precautions in using the technical information and semiconductors described in this material

- (1) An export permit needs to be obtained from the competent authorities of the Japanese Government if any of the products or technologies described in this material and controlled under the "Foreign Exchange and Foreign Trade Law" is to be exported or taken out of Japan.
- (2) The technical information described in this material is limited to showing representative characteristics and applied circuits examples of the products. It neither warrants non-infringement of intellectual property right or any other rights owned by our company or a third party, nor grants any license.
- (3) We are not liable for the infringement of rights owned by a third party arising out of the use of the product or technologies as described in this material.
- (4) The products described in this material are intended to be used for standard applications or general electronic equipment (such as office equipment, communications equipment, measuring instruments and household appliances).
Consult our sales staff in advance for information on the following applications:
 - Special applications (such as for airplanes, aerospace, automobiles, traffic control equipment, combustion equipment, life support systems and safety devices) in which exceptional quality and reliability are required, or if the failure or malfunction of the products may directly jeopardize life or harm the human body.
 - Any applications other than the standard applications intended.
- (5) The products and product specifications described in this material are subject to change without notice for modification and/or improvement. At the final stage of your design, purchasing, or use of the products, therefore, ask for the most up-to-date Product Standards in advance to make sure that the latest specifications satisfy your requirements.
- (6) When designing your equipment, comply with the guaranteed values, in particular those of maximum rating, the range of operating power supply voltage, and heat radiation characteristics. Otherwise, we will not be liable for any defect which may arise later in your equipment.
Even when the products are used within the guaranteed values, take into the consideration of incidence of break down and failure mode, possible to occur to semiconductor products. Measures on the systems such as redundant design, arresting the spread of fire or preventing glitch are recommended in order to prevent physical injury, fire, social damages, for example, by using the products.
- (7) When using products for which damp-proof packing is required, observe the conditions (including shelf life and amount of time let standing of unsealed items) agreed upon when specification sheets are individually exchanged.
- (8) This material may be not reprinted or reproduced whether wholly or partially, without the prior written permission of Matsushita Electric Industrial Co., Ltd.